

sceneCOM evo DA2

sceneCOM evo DA2 – multi-channel lighting controller

Product description

- Single Master DALI-2 application controller
- Independent lighting control for up to 192 DALI control gears on 3 DALI lines
- Compatible with MSensor G3 and XC G3 DALI-2 controls
- Simple setup via WEB interface
- Cross DALI line control
- Extension of functionalities via software licenses
- DALI emergency lighting control gear test scheduling and monitoring (number of emergency lighting units depending on the activated software license)
- Complying with IEC 62034
- 5 years guarantee (conditions at www.tridonic.com)

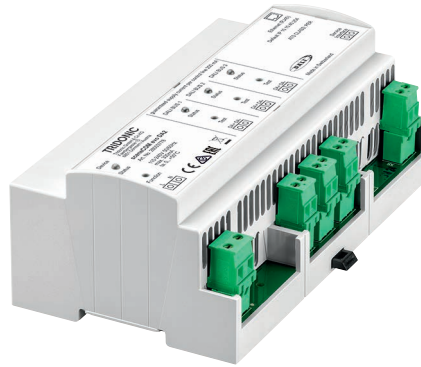

Housing properties

- Casing: polycarbonate, white
- Type of protection IP20
- DIN rail mounting

Interfaces

- 3 DALI lines
- BACnet interface (depending on the license model)
- Terminal blocks: screw terminals

Functions

- Addressing wizard
- Presence linking
- Local and downloadable backup
- Freely programmable daily scheduling with calendar function
- Self-contained emergency luminaires (depending on the license model)
- Daylight control (depending on the license model)
- Freely programmable shows (depending on the license model)
- RGB and Tunable White (depending on the license model)
- Scenes and zones



Wiring diagrams and installation examples, page 5



sceneCOM evo DA2

sceneCOM evo DA2 – multi-channel lighting controller

Technical data

Rated supply voltage	110 – 240 V
Mains frequency	50 / 60 Hz
Power consumption	< 20 W
Ethernet interface	1 x RJ45
DALI interface	3 x
Max. current per channel	200 mA
Ethernet port	1 x 10/100 Mbit/s
Status indicators LED	Device status, DALI status
Operating Temperature at upright mounted	0 ... +50°C
Operating Temperature at flat mounted	0 ... +40°C
Mounting	DIN rail mounting, 35 mm
Casing Material	PC, halogen-free polycarbonate, non-flammable
Type of Protection	IP20
Guarantee (conditions at www.tridonic.com)	5 years
Dimensions L x W x H	160 x 91 x 62 mm

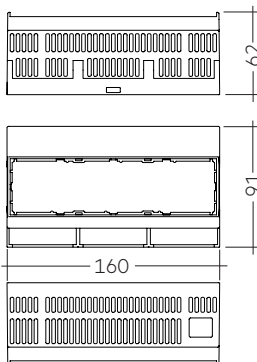

Ordering data

Type	Article number	Packaging carton	Weight per pcs.
sceneCOM evo DA2	28003778	36 pc(s).	0.37 kg

1. Standards

IEC 60950-1
EN 55022
EN 55024
EN 61547
EN 61000-4-3
EN 61000-6-1
EN 61000-6-3
IEC 61347-2-11
EN 62386-101 Ed.2
EN 62386-103 Ed.1

2. Common

2.1 Description

sceneCOM evo DA2 is a DALI-2 lighting management system which is compatible with the G3 MSensors and the XC G3 from the Tridonic DALI-2 portfolio.

sceneCOM evo DA2 is designed to easily control your luminaires.

The sceneCOM evo DA2 web application allows the automation of up to 192 luminaires with one sceneCOM evo DA2 control device.

The sceneCOM evo DA2 web application is therefore suitable for smaller and larger buildings or individual floors.

Besides the functional lighting in a building, self-contained emergency luminaires can also be used in a sceneCOM evo DA2 system.

3. Interfaces / communication

3.1 Device LED

Status-LED	Description
Green, intermittently flickering	Fault-free operation
Off	No mains voltage (L, N)
Red	Serious internal error

3.2 DALI LED

Status-LED	Description
Green, intermittently flickering	Fault-free operation
Green, flashing on/off every 0.5 s	Test mode
Orange, flashing on/off every 0.5 s	Addressing or DALI initialisation
Off	No mains voltage (L, N)
Red	More than 64 DALI-compliant devices connected
Red, intermittently flickering	DALI control line short-circuited or more than 100 DALI loads
Red-green, intermittently flickering	Lamp failure

3.3 Function key

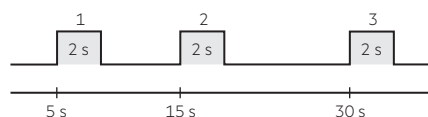

Orange phase	Function
1	Restart the sceneCOM evo DA2.
2	Delete the addresses and short addresses of all control gear and input devices connected to the 3 DALI control lines.
3	Reset the IP address to the factory setting (10.10.40.254).

3.4 Function switch

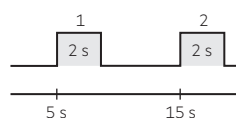

Orange phase	Function
1	Exit test mode for all outputs.
2	Delete the addresses and short addresses of all control gear and input devices connected to the corresponding DALI control line.

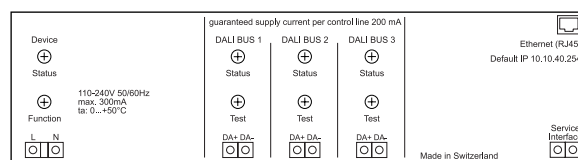

4. Installation

4.1 Safety instructions



The device may only be used for the specified area of application.

Relevant health and safety regulations must be observed.

The voltage supply must be disconnected when the device is being assembled and installed.

Only qualified personnel may assemble, install and commission the device.

Protection class II can only be guaranteed when the terminal covering has been correctly installed.

If a fault occurs, dangerous voltage levels may be present at the DALI terminals and on the DALI control line.

4.2 Wiring examples

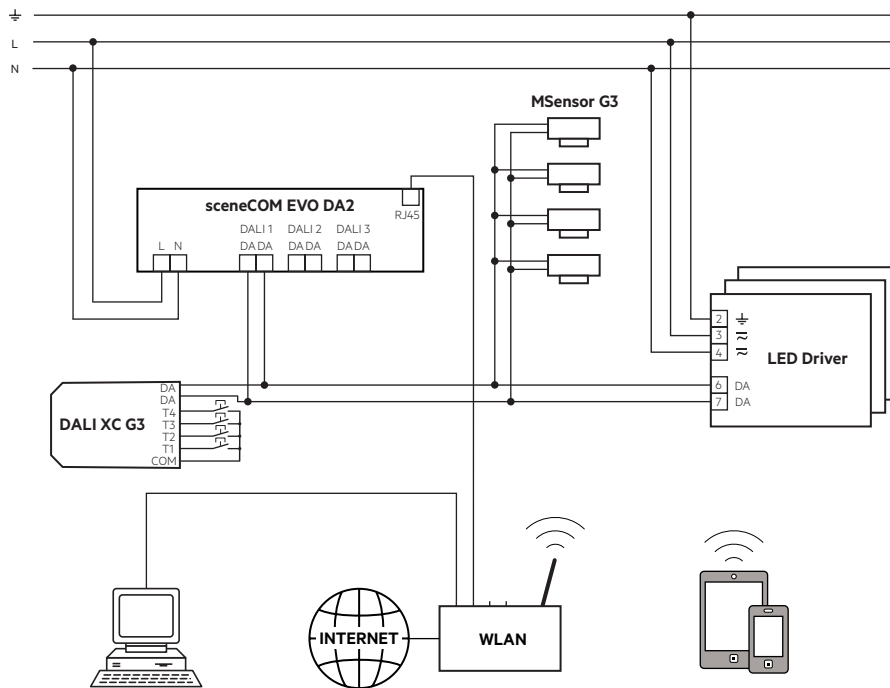

4.3 Wiring type and cross section sceneCOM evo DA2 Controller

For wiring use stranded wire with ferrules or solid wire from 0.5 to 2.5 mm².

wire preparation:
0.5 – 2.5 mm²

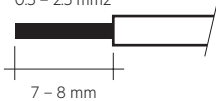

5. em-LINK

The em-LINK software allows you to remotely monitor the status of all connected emergency gears from up to 200 sceneCOM evo DA2 controllers. It is accessible via WEB interface. More information on the em-LINK software can be found in its manual or at www.tridonic.com/software.

6. Miscellaneous

6.1 Disposal of equipment



Return old devices in accordance with the WEEE directive to suitable recycling facilities.

6.2 Additional information

Additional technical information at www.tridonic.com → Technical Data

Lifetime declarations are informative and represent no warranty claim. No warranty if device was opened.